

# CADERNO EXECUTIVO

Projeto de interiores  
Detalhamentos

✉ [thais.barauna@outlook.com](mailto:thais.barauna@outlook.com)

☎ (49) 9 9915-0025

📷 [@thaisbarauna.arq](https://www.instagram.com/thaisbarauna.arq)

THAÍS|  
BARAUNA  
*arquitetura*

## ESPECIFICAÇÕES GERAIS

Cor: Nobile

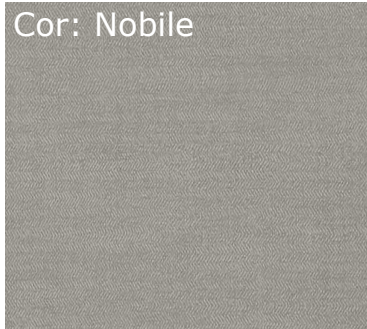

Cor: Portoro



Reformas:

conferir tonalidades  
in loco



Cor: Itapuã



Perfis LED de embutir 4.000K

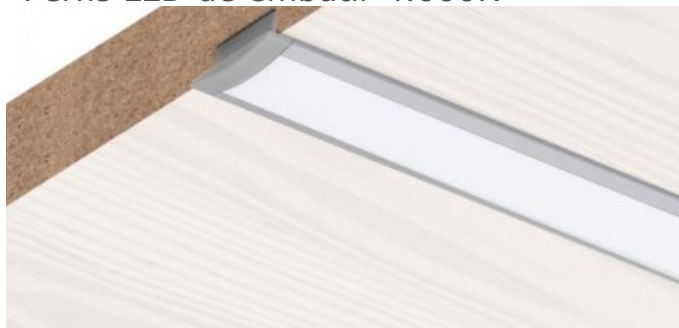

## ORIENTAÇÕES GERAIS

- . Antes do início da execução deverá ser marcada reunião;
- . Todas as medidas devem obrigatoriamente serem conferidas no local antes de qualquer execução;
- . Mobiliário deverá ser produzido em MDF 18 mm;
- . Quando houver puxadores não especificados no mobiliário, os mesmos deverão ser definidos junto ao pessoal terceirizado;
- . Após a realização de cada serviço prestado o responsável deve executar a limpeza do local, no que diz respeito ao seu trabalho;
- . Qualquer dúvida deve ser solucionada com a presença da Arquiteta responsável (antes da execução).

THAÍS|  
BARAUNA  
*arquitetura*

# ORDEM DE APRESENTAÇÃO DO CADERNO

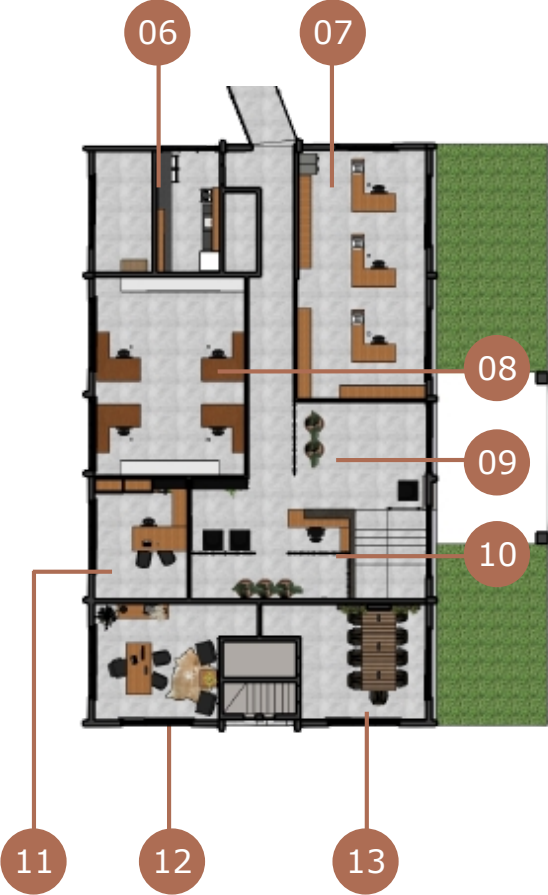

Planta Baixa - Pav Superior  
*FRENTE*



Sala

06

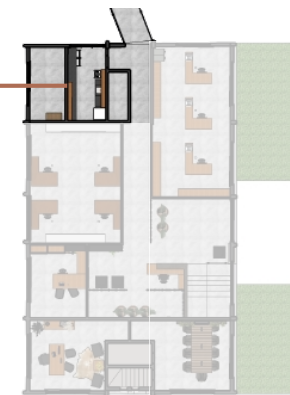

• Ambiente com modificações

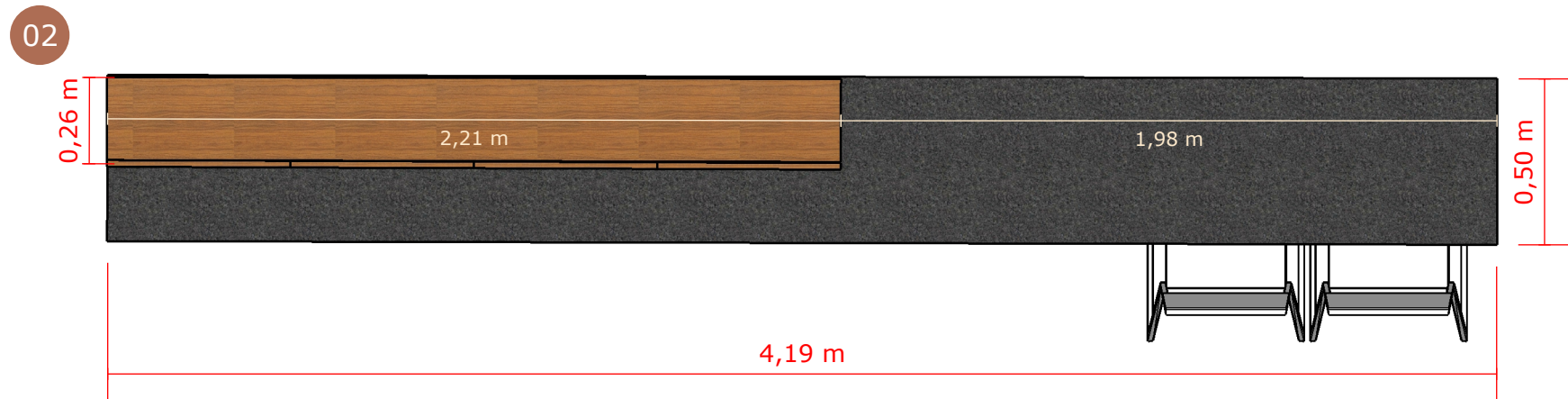
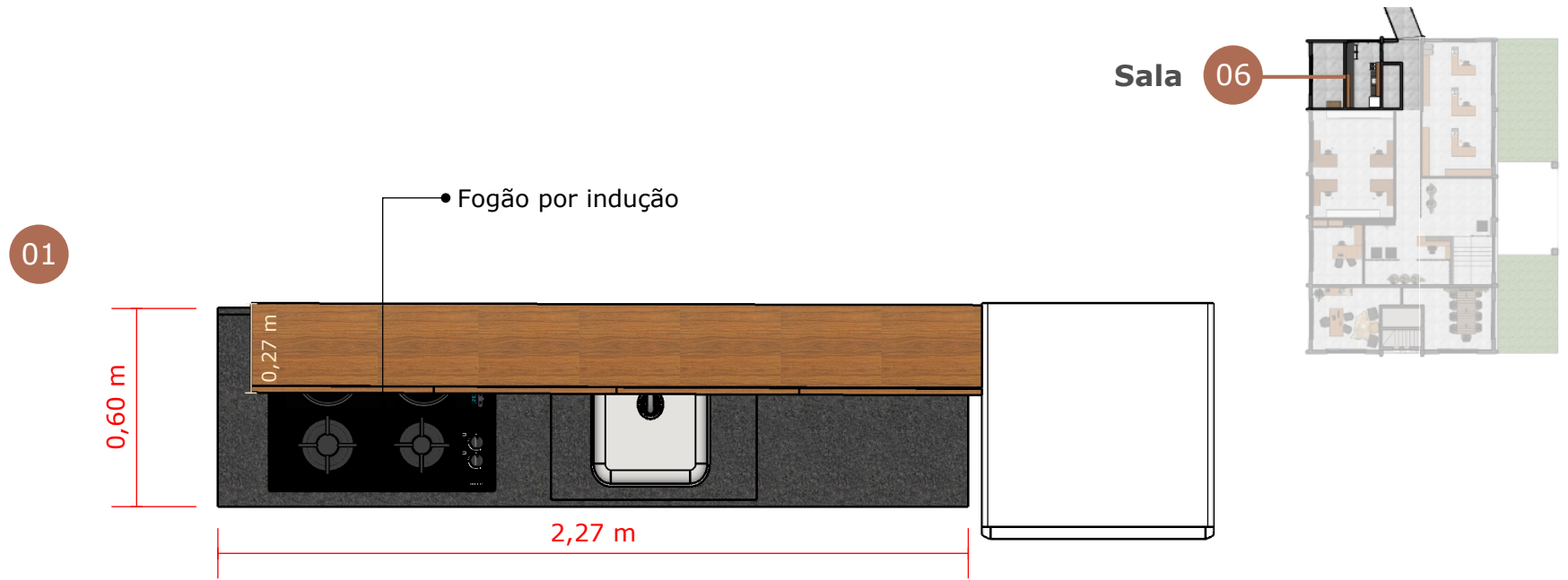

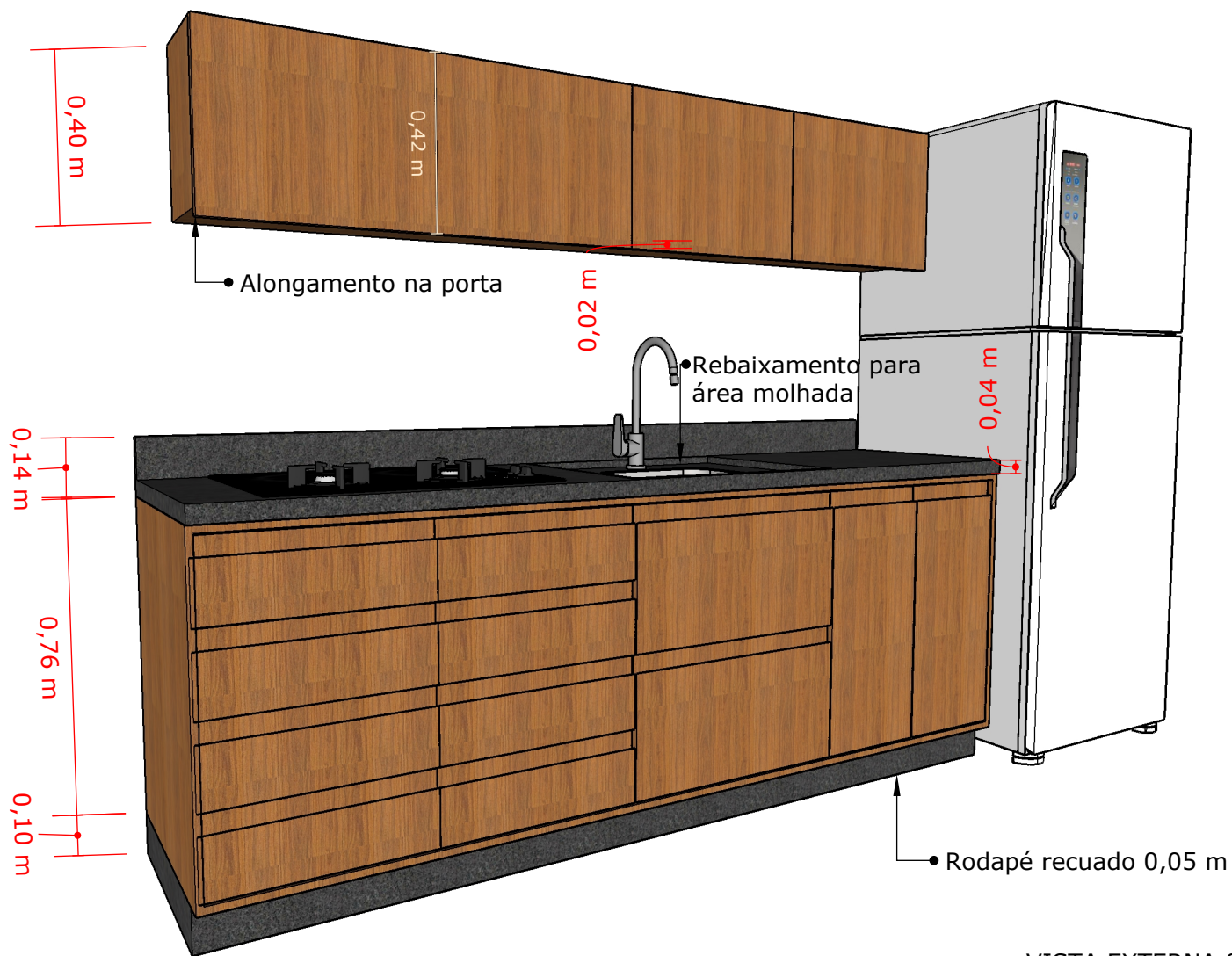

VISTA EXTERNA 01  
(perspectiva)

Detalhamento Puxador Cava

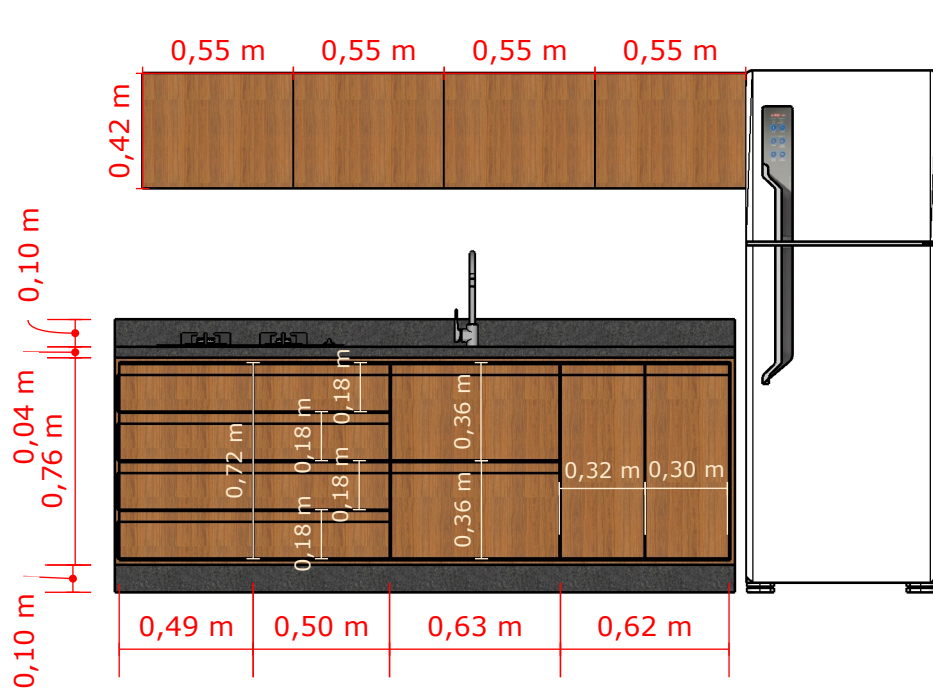
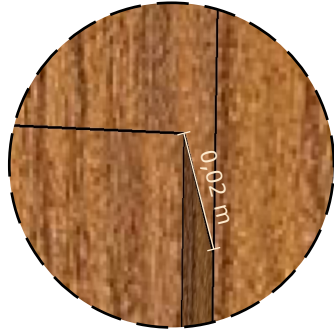

VISTA EXTERNA 01  
(frontal)

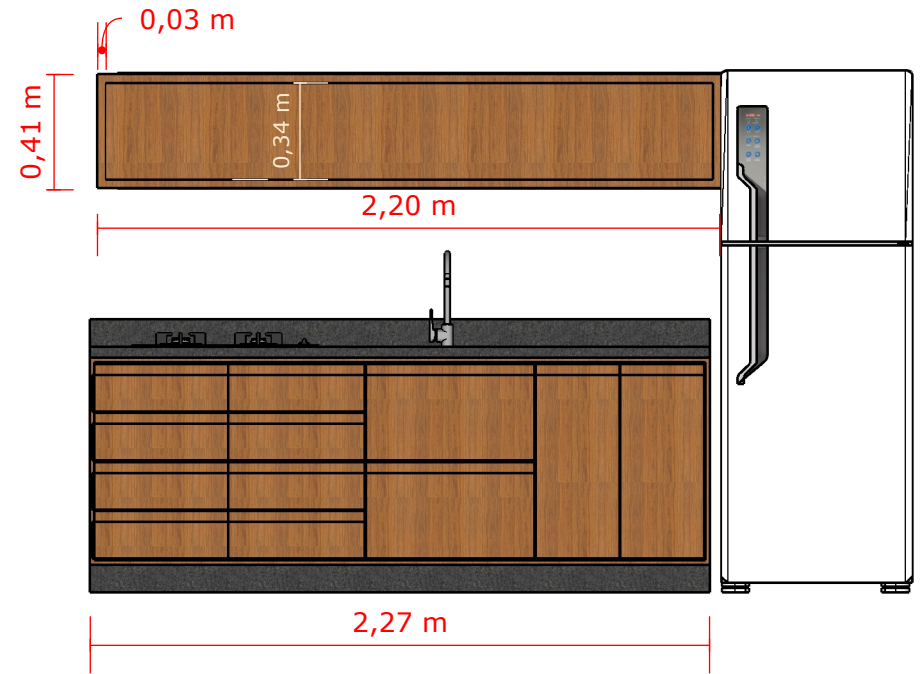

VISTA INTERNA 01  
(frontal)

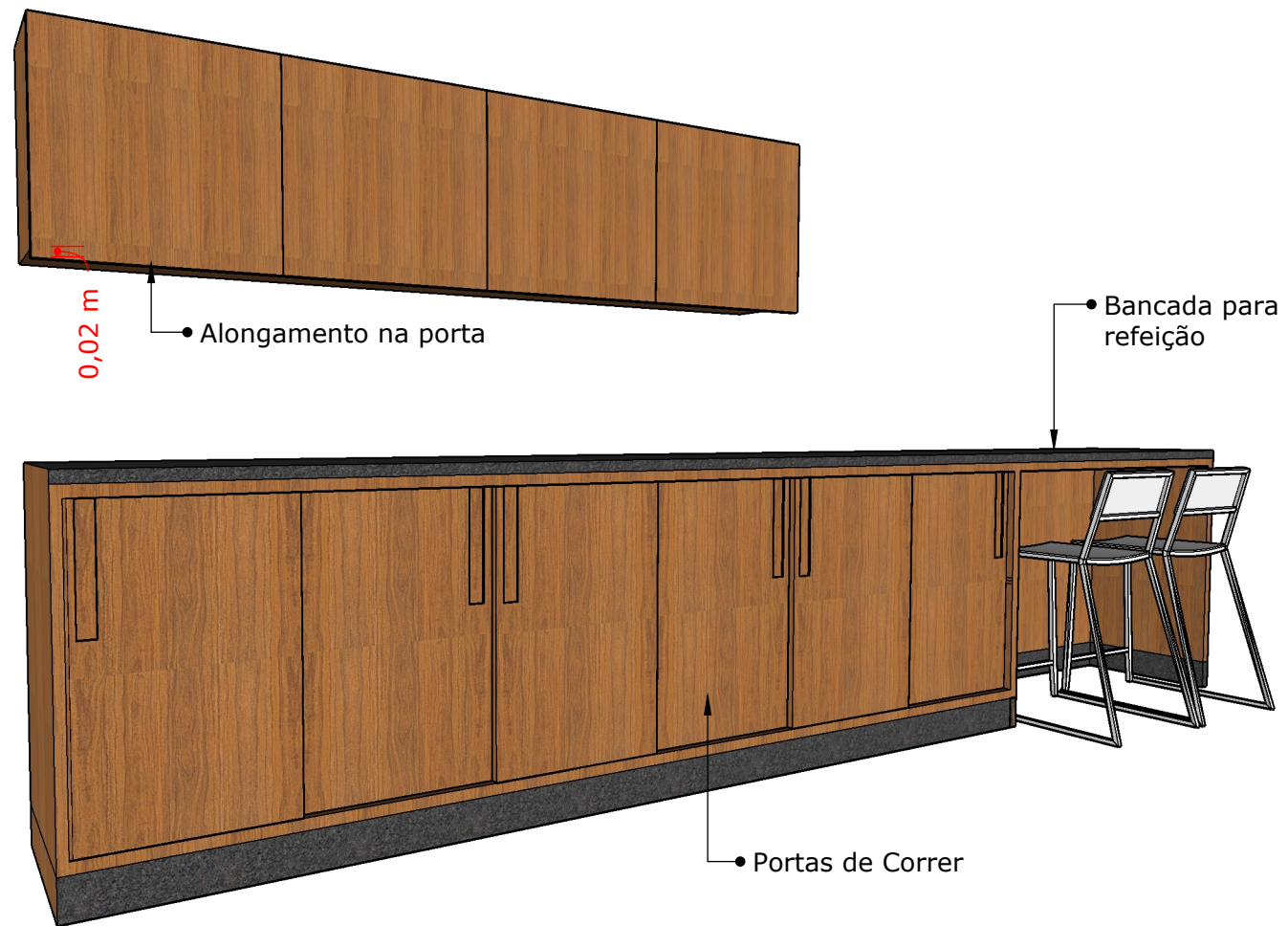

VISTA EXTERNA 02  
(perspectiva)



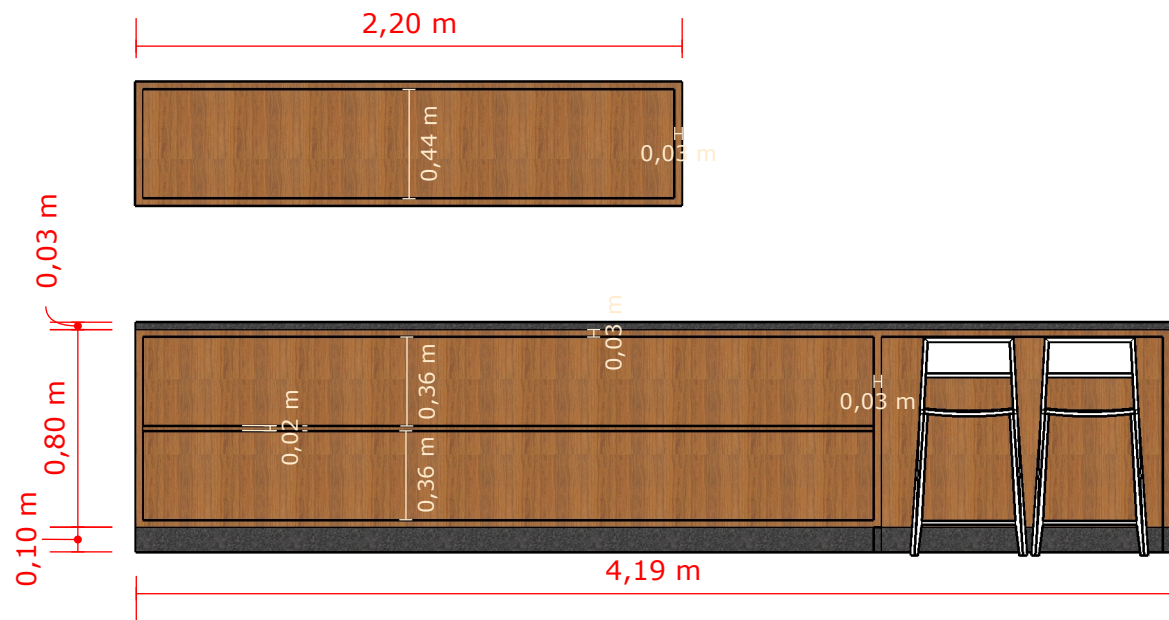

VISTA INTERNA 02  
(frontal)

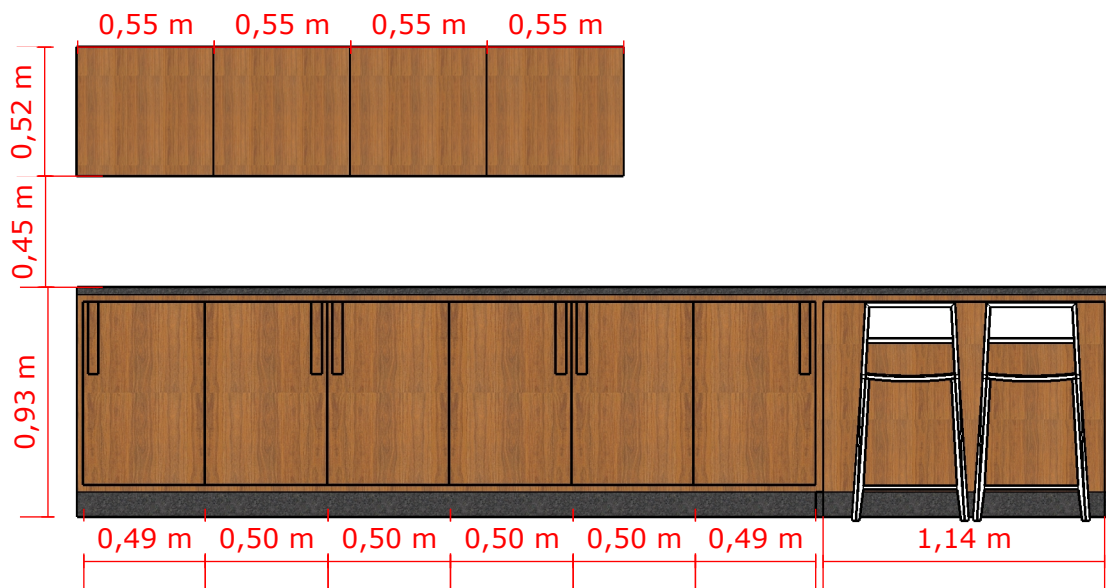

VISTA EXTERNA 02  
(frontal)



Sala

07



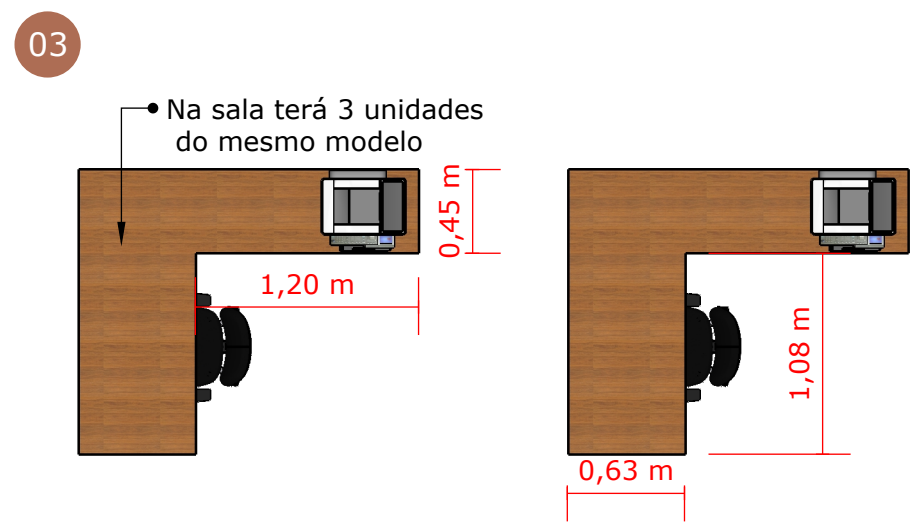
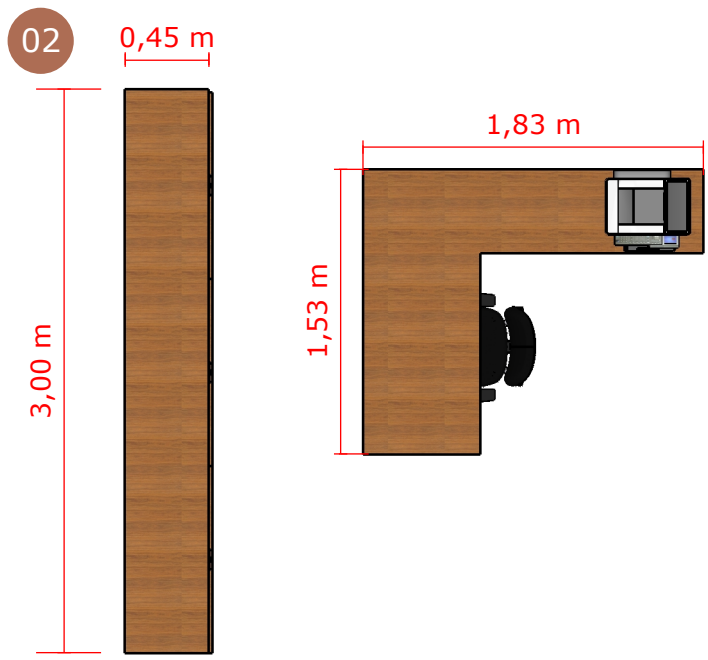
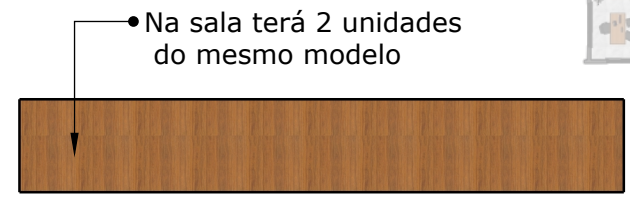
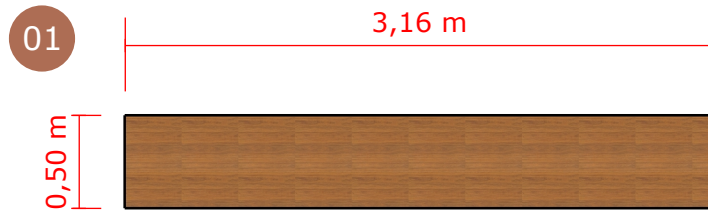

VISTA EXTERNA (superior)

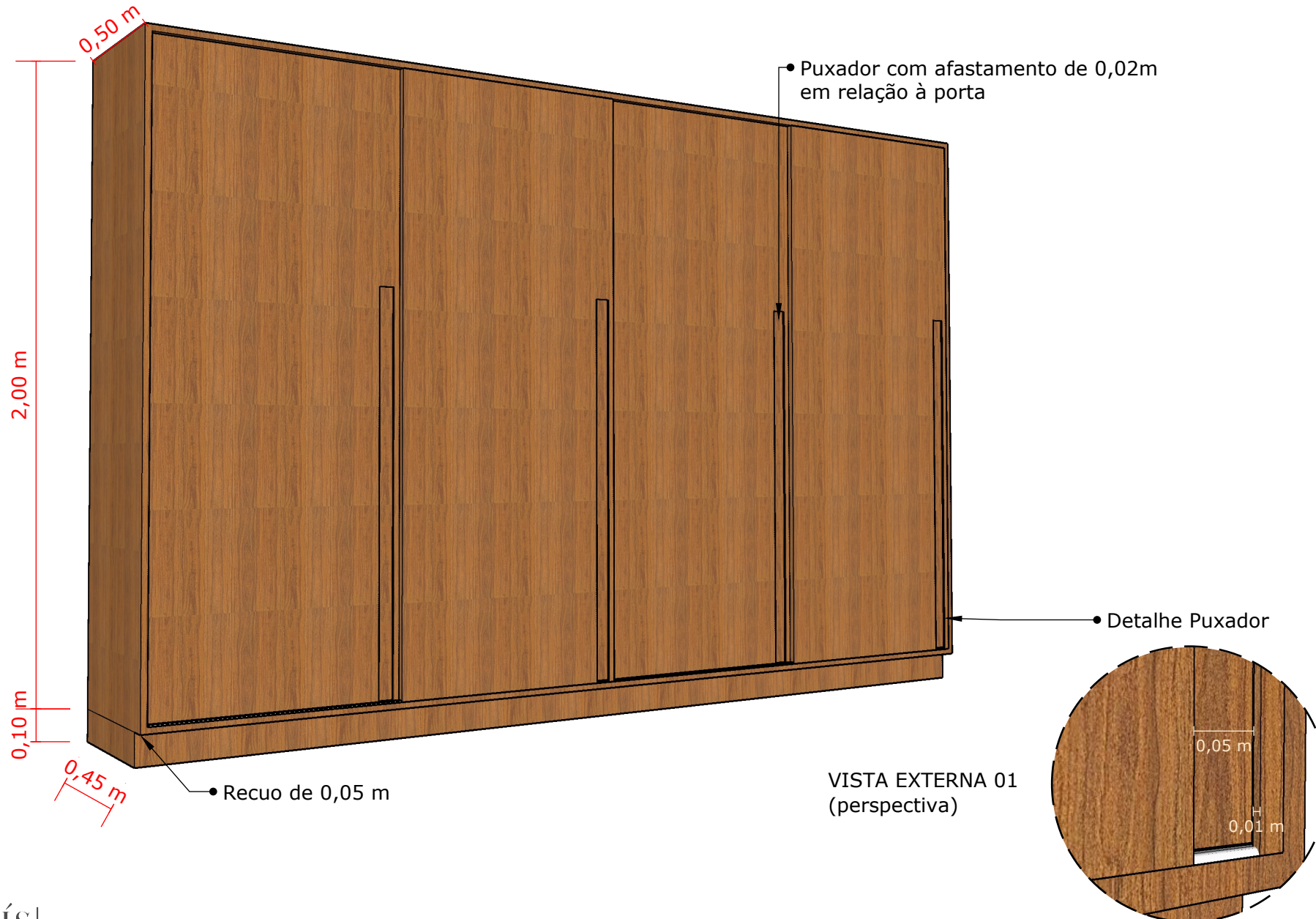

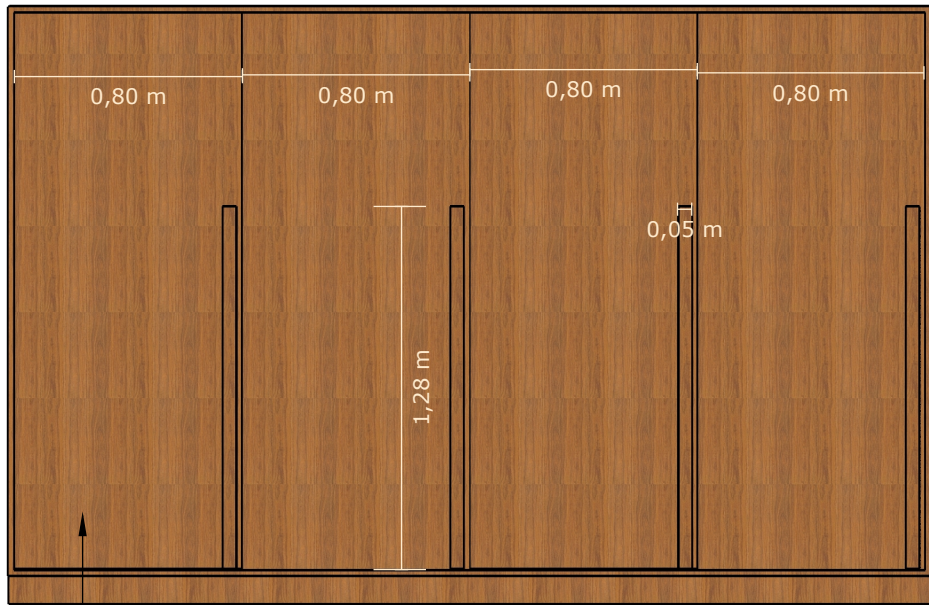

• Portas de Correr

VISTA EXTERNA 01  
(frontal)

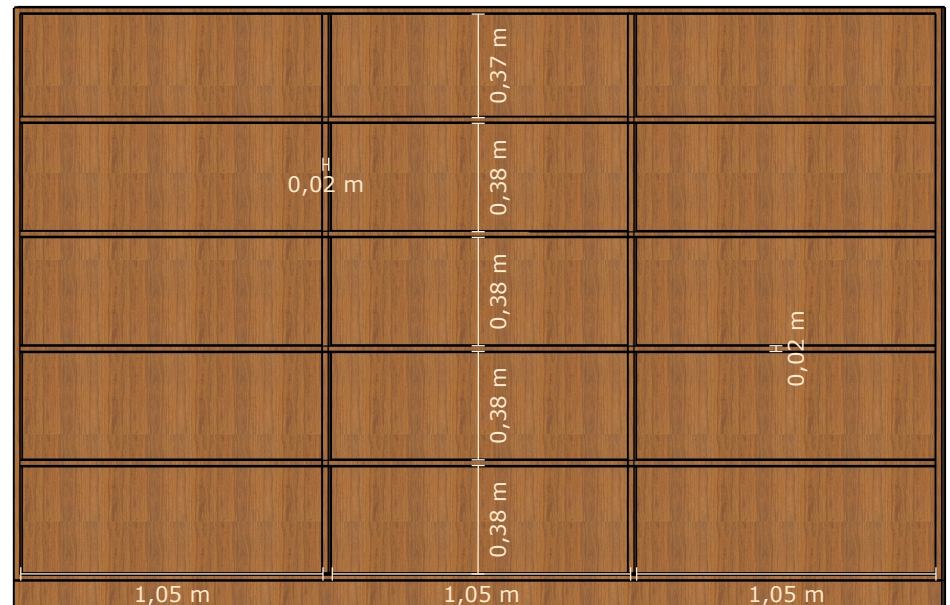

VISTA INTERNA 01  
(frontal)

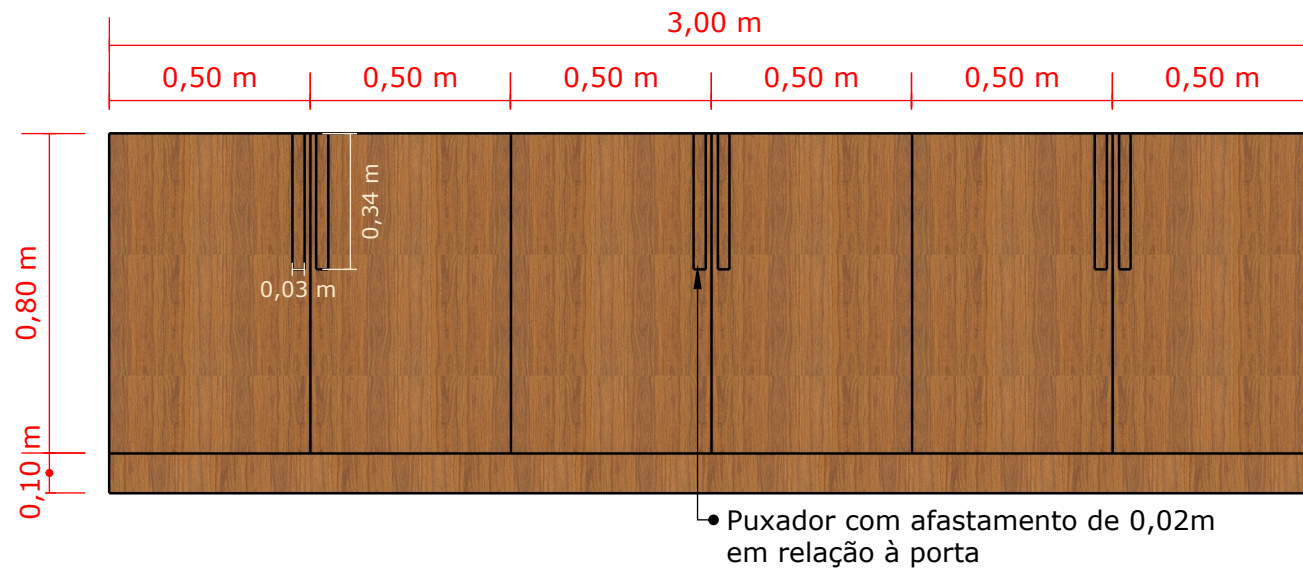

VISTA EXTERNA 02  
(frontal)

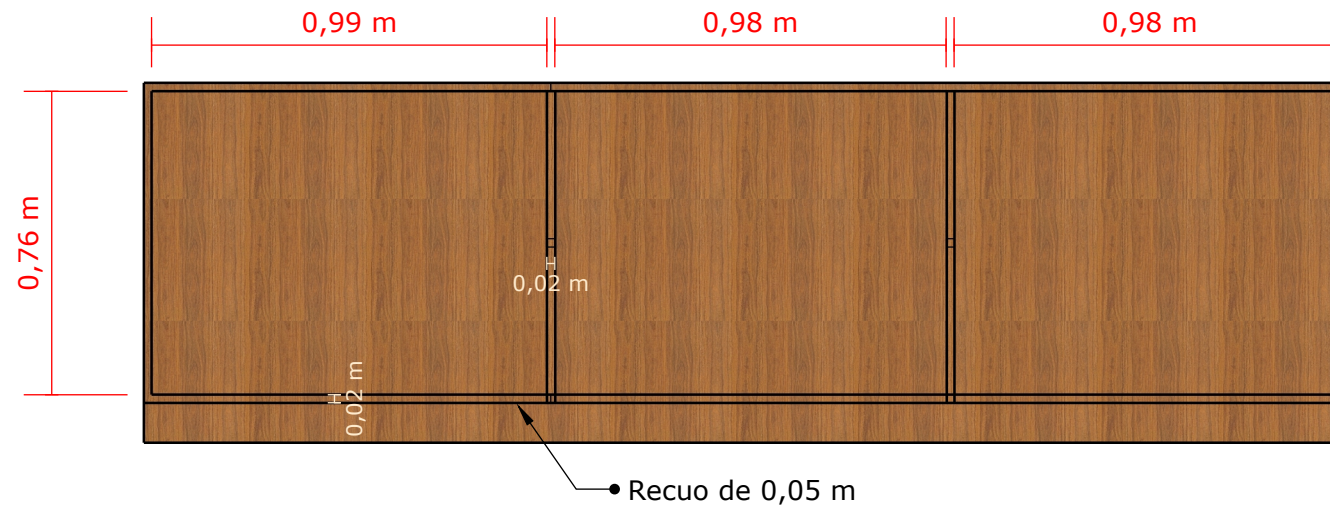

VISTA INTERNA 02  
(frontal)



• Gavetas com fechadura

VISTA EXTERNA 03  
(perspectiva)

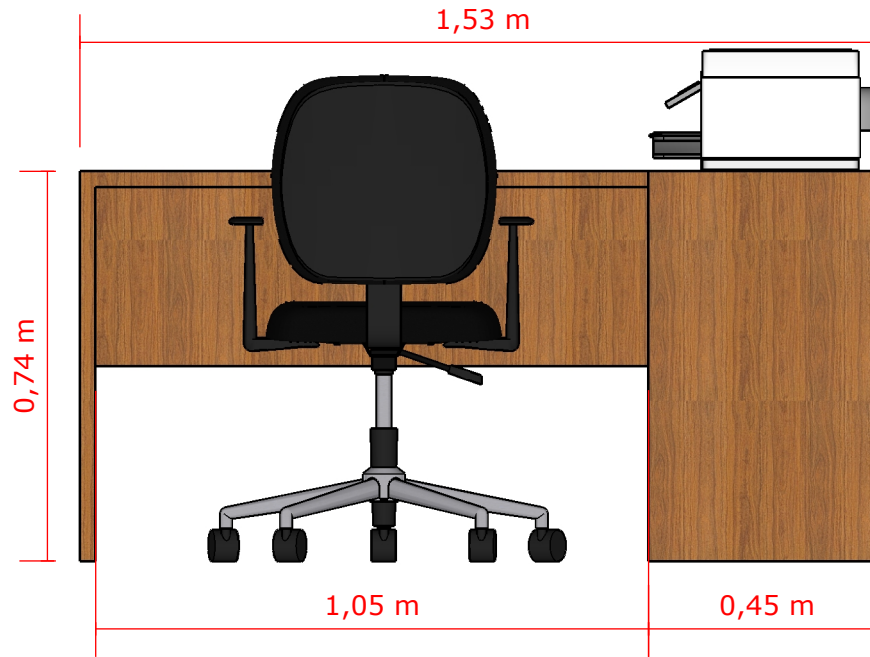

VISTA EXTERNA 03  
(fundos)

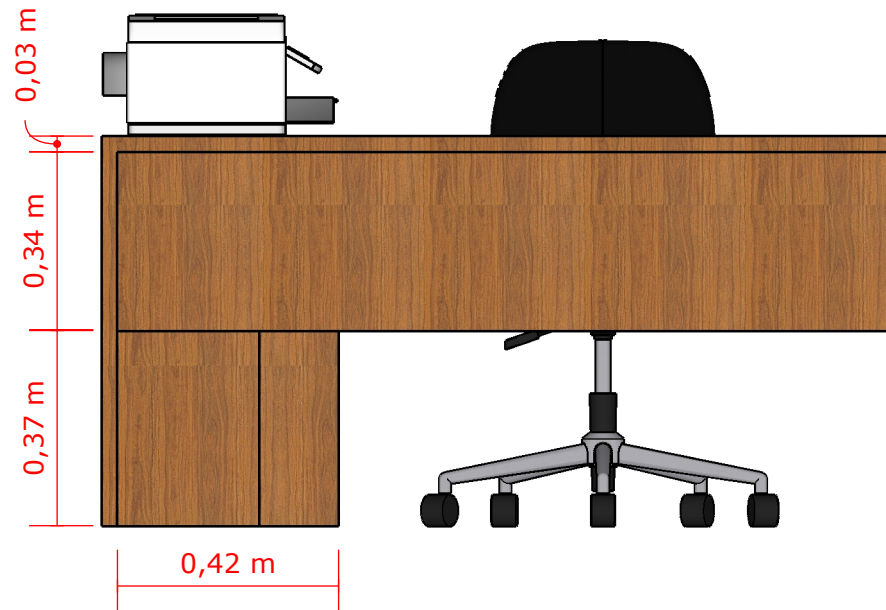

VISTA EXTERNA 03  
(frontal)





Sala

08





Sala

08



• Detalhe Puxador Cava

VISTA EXTERNA  
(perspectiva)

Lâmina em MDF  
XXXX

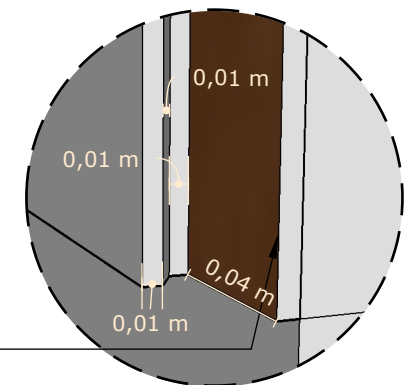

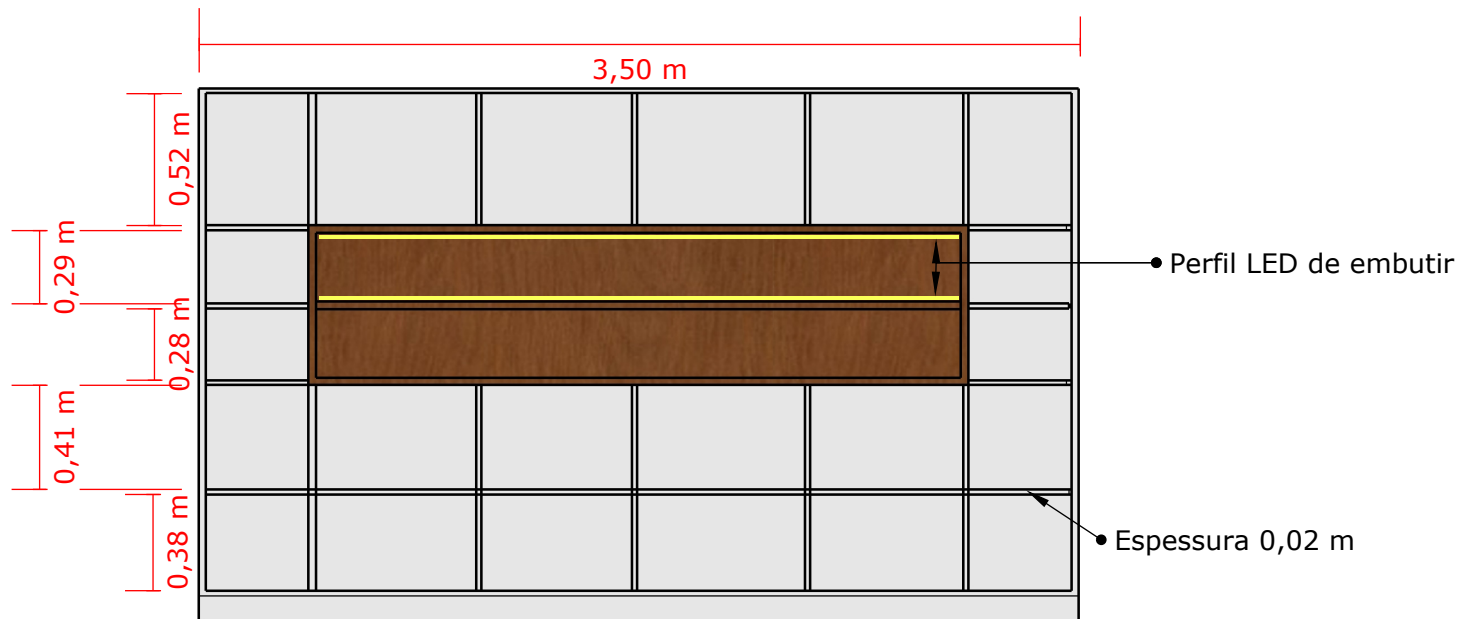

VISTA INTERNA  
(frontal)

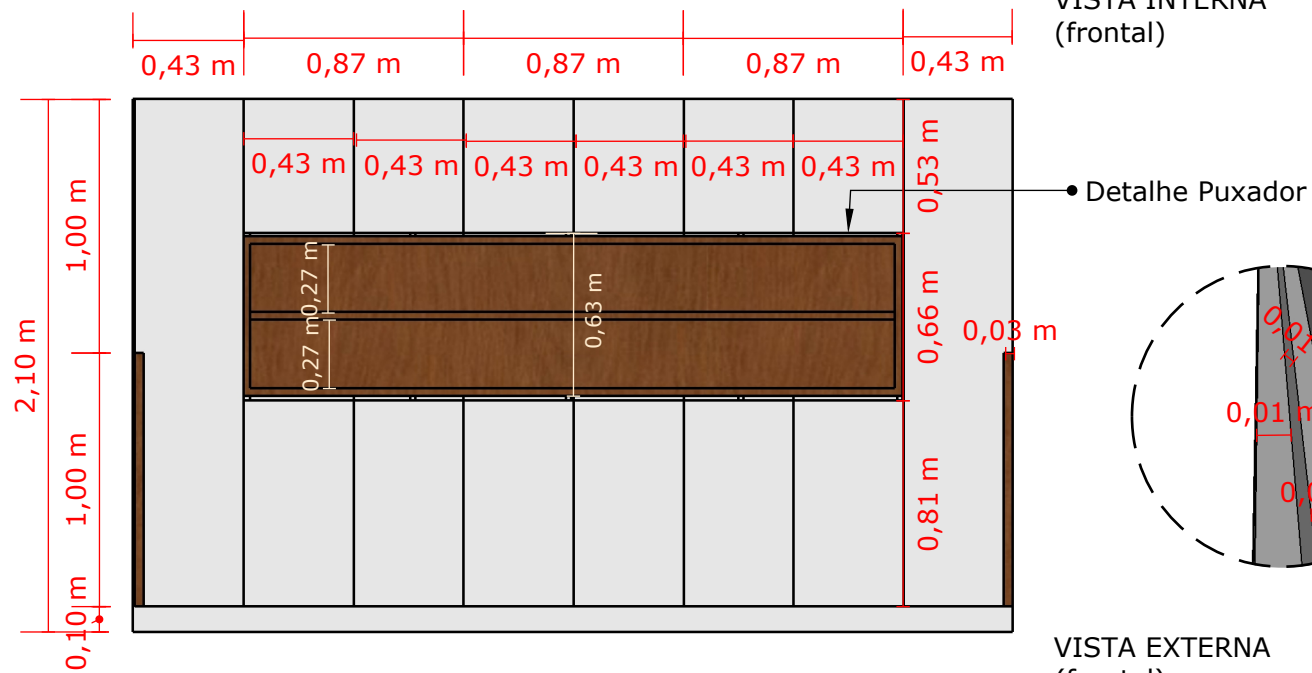

VISTA EXTERNA  
(frontal)

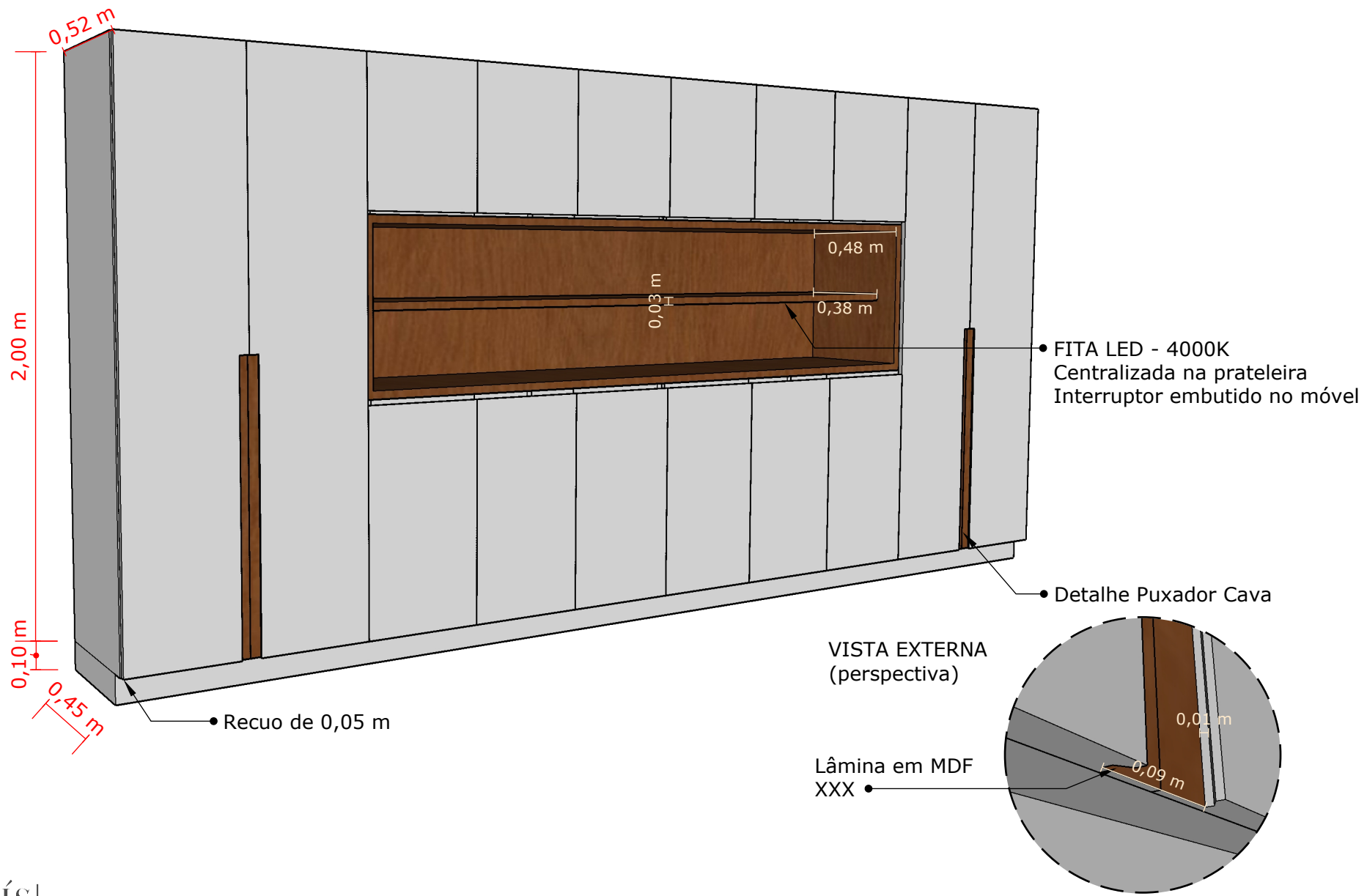

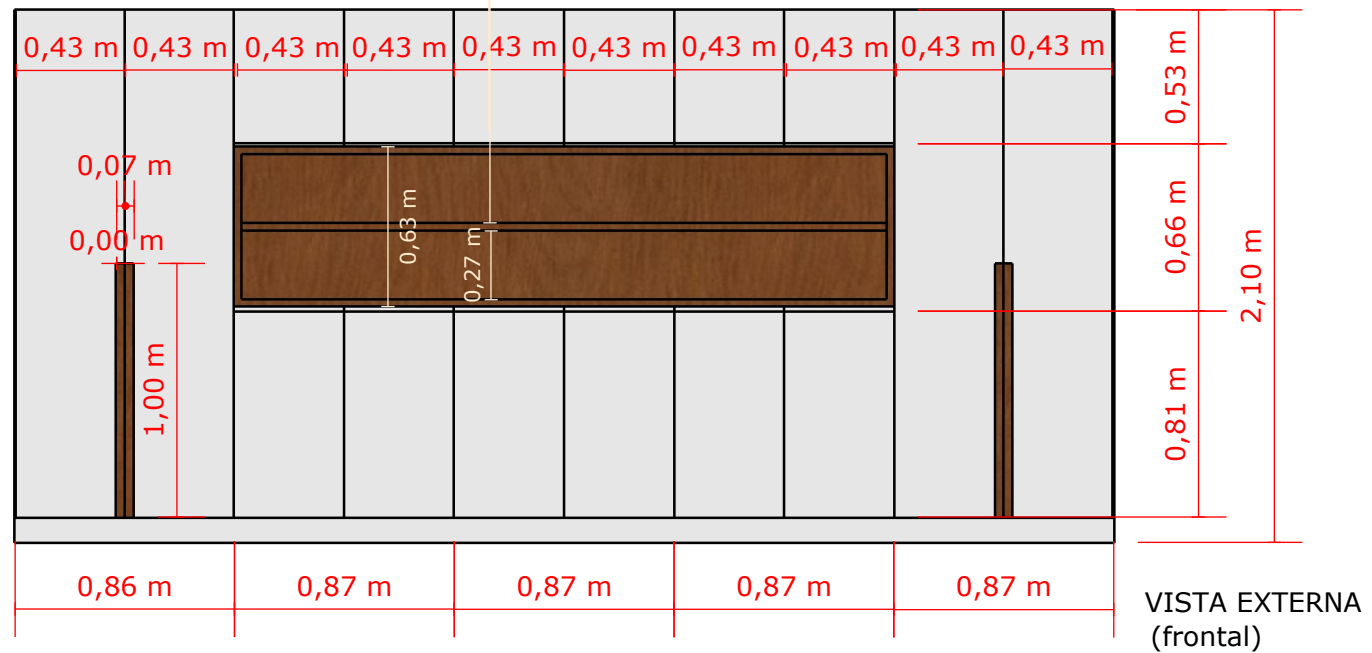
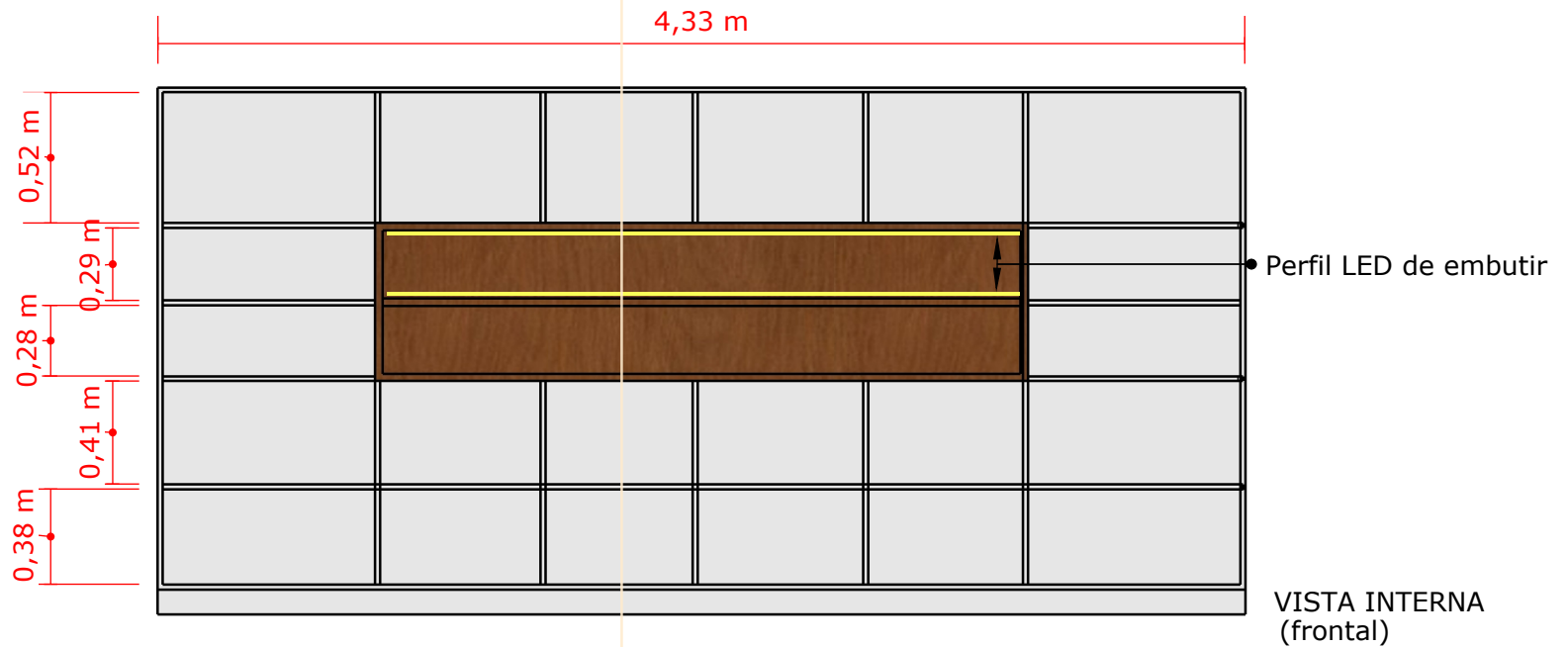

• Na sala terá 4 unidades do mesmo modelo

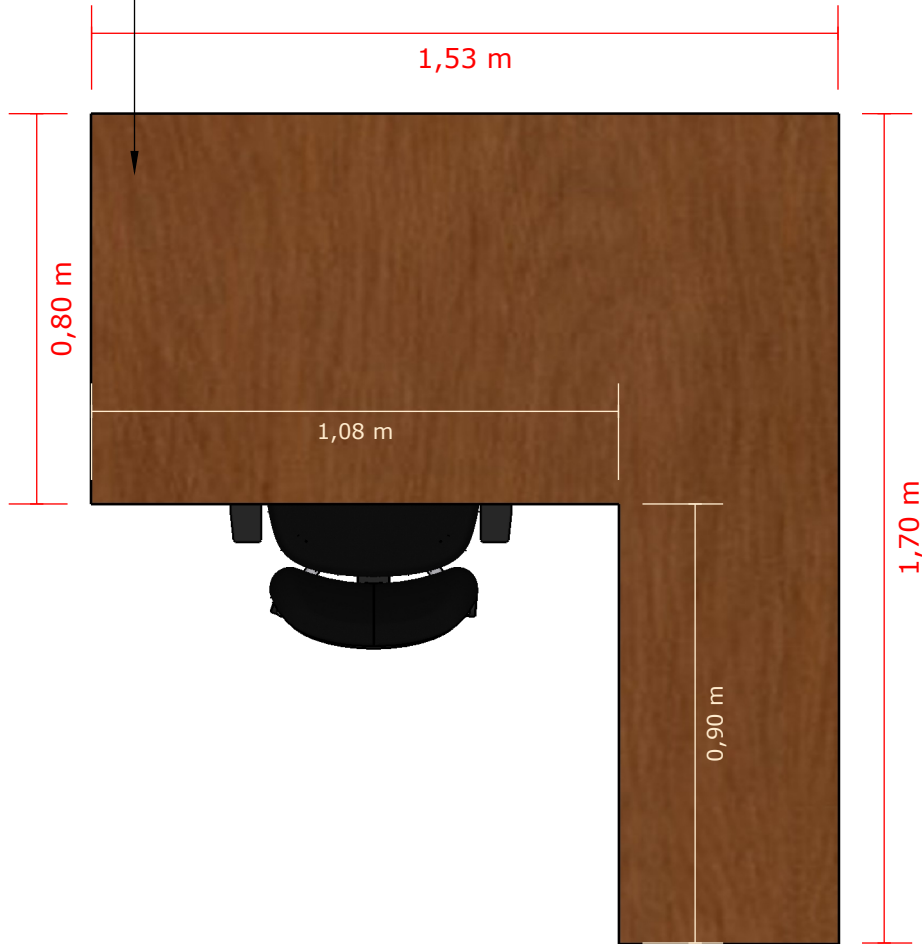

VISTA EXTERNA (superior)



VISTA EXTERNA (perspectiva)



VISTA EXTERNA (frontal)